

A Assembly instruction Witch's Look Out Art No. 4594-11



Revision history

Revision 0 – 2004-09-20

The first allowed version

Assembly instruction

Revision 3 – 2011-07-04

Sicherheitsbereich FH

All rights reserved

© Copyright 2004 Huck Seiltechnik GmbH

Contents

	Introduction Assembling	4
2	Datasheet “Berghausen” gnome wood, (registered design) article 4594-11	5
3	Delivery contents (parts list with part numbers)	6
4	Erection instructions	8
5	Post installation checks	12
B	Maintenance instructions “Berghausen” gnome wood (registered design) Art. 4594-11	13
6	Introduction Maintenance	15
7	General maintenance information	16
8	Specific maintenance advice	17
9	Maintenance timetable	18
10	Monthly maintenance	19
11	Quarterly maintenance	19
12	Annual maintenance	20
13	Maintenance printout	21
14	Hand over document	23

List of Tables

Table 3-1: Delivery contents, in words	6
Table 3-2: Delivery contents, in symbols	7

1 Introduction Assembling

1.1 General information

This equipment should be installed, inspected, maintained and operated in accordance with EN1176-7 guidelines.

Before installation work commences, please check that you have all of the equipment and fixation components in the parts list provided (see Tables 3-1 and 3-2).

Any spare parts that may be required can be obtained directly from your supplier.

Please do not hesitate to call us on **01308 425100** if you have any problems during installation or with any other questions.



Attention

Following installation, complete assembly instructions, maintenance instructions and a maintenance record must be sent to the operator who must confirm receipt in writing. See the last page of this document.



Attention

All nuts and bolts are hot-dip galvanised or stainless steel.

One of the characteristics of stainless steel is that uncontrolled cold welding may occur when the nuts are tightened. To prevent this, it is necessary to spray the nuts and bolts with Teflon spray or another similar lubricant.

We hereby confirm that this play equipment has been tested and certified in accordance with the play equipment standard EN 1176.

2 Datasheet “Berghausen” gnome wood, (registered design) article 4594-11

1. Space requirement: 3.30 m x 1.90 m and/or 6.30 m x 4.90 m including safety zone, height of fall 1.10 m
2. Required safety surface:

Surface material	Description mm	Minimum thickness of layer mm	Maximum height of fall mm
Topsoil grass			<= 1000*
Chipped bark	20 – 80 grain size	300	<= 2000
		400	<= 3000
Wood chippings	5 – 30 grain size	300	<= 2000
		400	<= 3000
Sand	0.2 – 2 grain size	300	<= 2000
		400	<= 3000
Gravel	2 – 8 grain size	300	<= 2000
		400	<= 3000
Other ground materials	As recommended by manufacturer		

3. Name and overall dimension of the largest component:
 Steel post (5 pieces) length 2.00 m, ø 102 mm
4. Name and weight of the heaviest component:
 Steel posts (1 pallett), approx. 75 kg
5. Intended age group: 3 years and over
6. **Please note that this equipment is set in concrete.**
 Concrete: C25/30
 Required concrete: approx. 1.0 m³
 Foundations/area to be excavated:
 5 x 0.70 m long x 0.70 m wide, total depth 0.80 m including 10 cm drainage
 Top edge of concrete 40 cm resp. 30 cm below ground level
7. Assembly time, once foundations complete: approx. 1,5 hours.
 Required assistance: 1 - 2 people.
8. Any spare parts which may be required can be obtained directly from your supplier
9. **We hereby confirm that this item of play equipment has been tested and certified in accordance with the play equipment standard EN 1176.**

3 Delivery contents (parts list with part numbers)









3.1 In words

Table 3-1: Delivery contents, in words

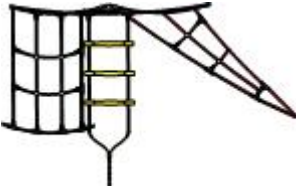
Pos.	Quantity	Element / Description	Size	O.K.	Missing
1	5	Steel post	Ø 102 mm, 2.00 m lg.		
2	5	Red caps	for Ø 102 mm		
2	1	Play part (net)			
4	1	Play part (net with tyre)			
100	14	Pipe shackles	for Ø 102 mm		
101	15	Pias screws (self drilling)	4.8 x 25 mm		
102	1	Screw-in anchors			
103	5	Threaded bolts	M10 x 100 with 2 hexagonal nuts each		
104	1	Red paint (tin) with paintbrush			

3.2 In symbols

Table 3-2: Delivery contents, in symbols

Pos.	Quantity	Symbol
1	5	
2	5	
3	1	
4	1	
100	9	
101	15	
102	1	
103	5	
104	1	

4 Erection instructions

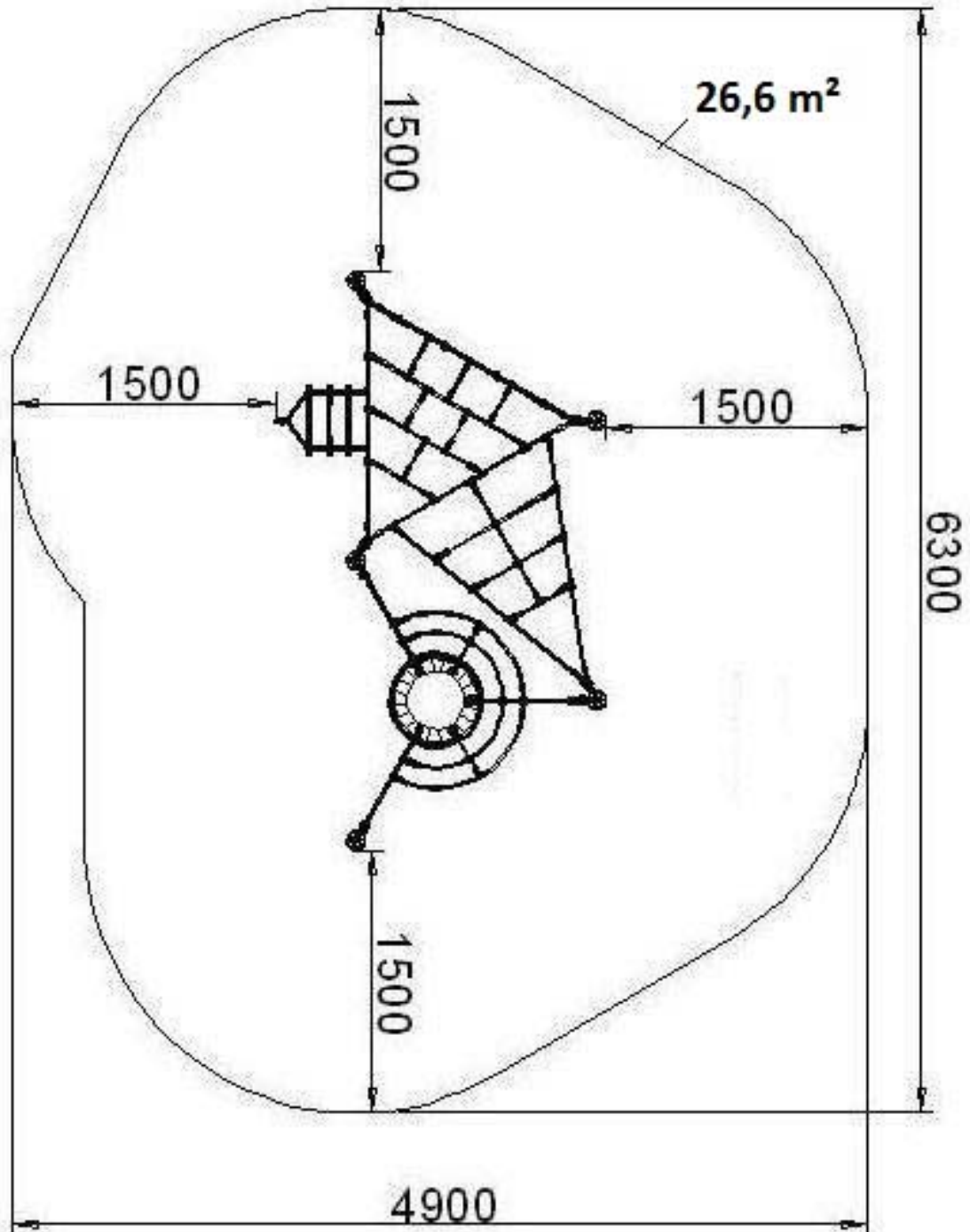

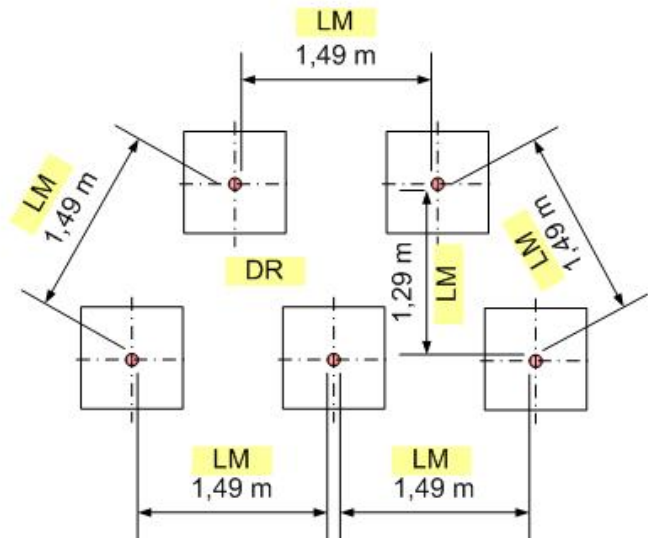
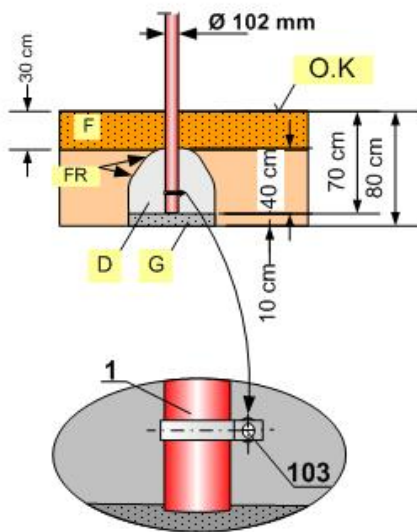
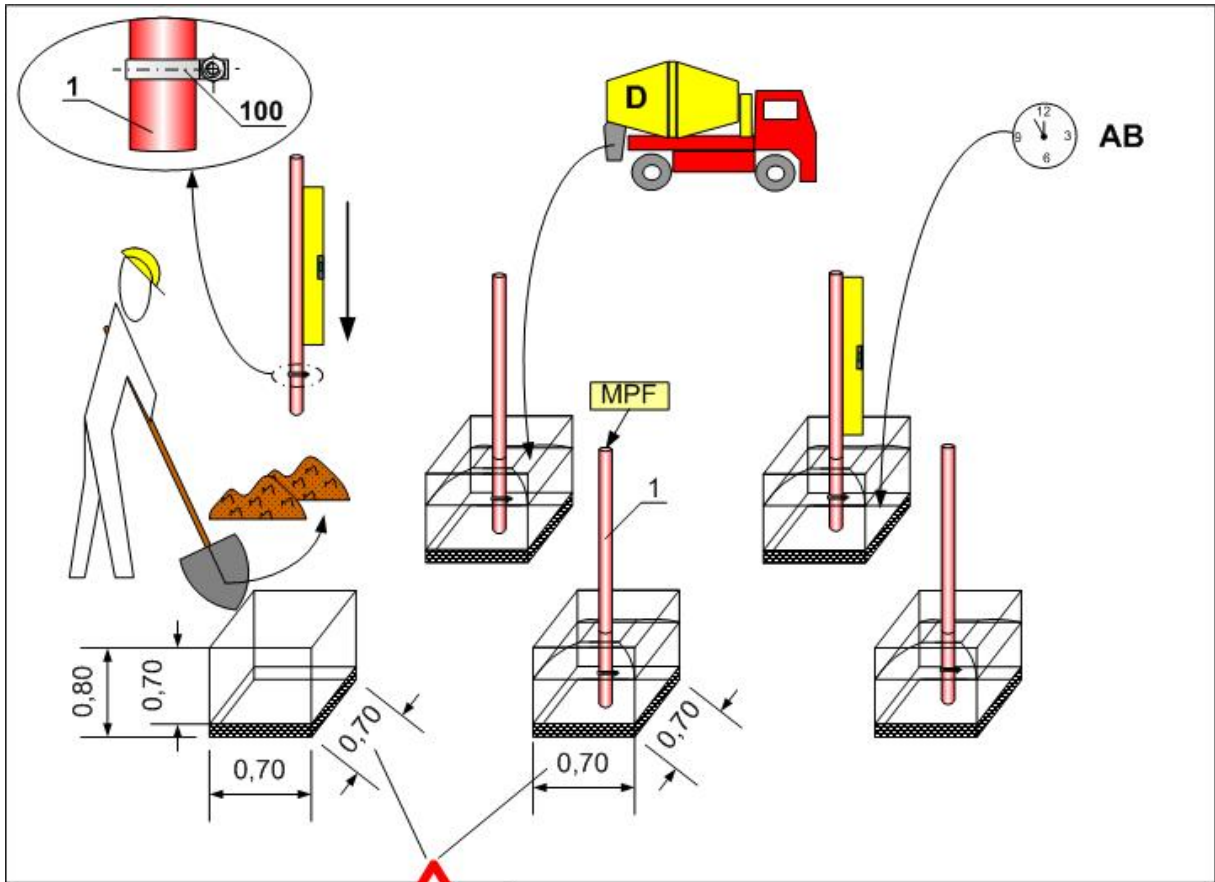

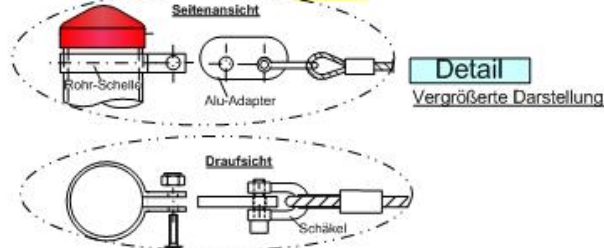
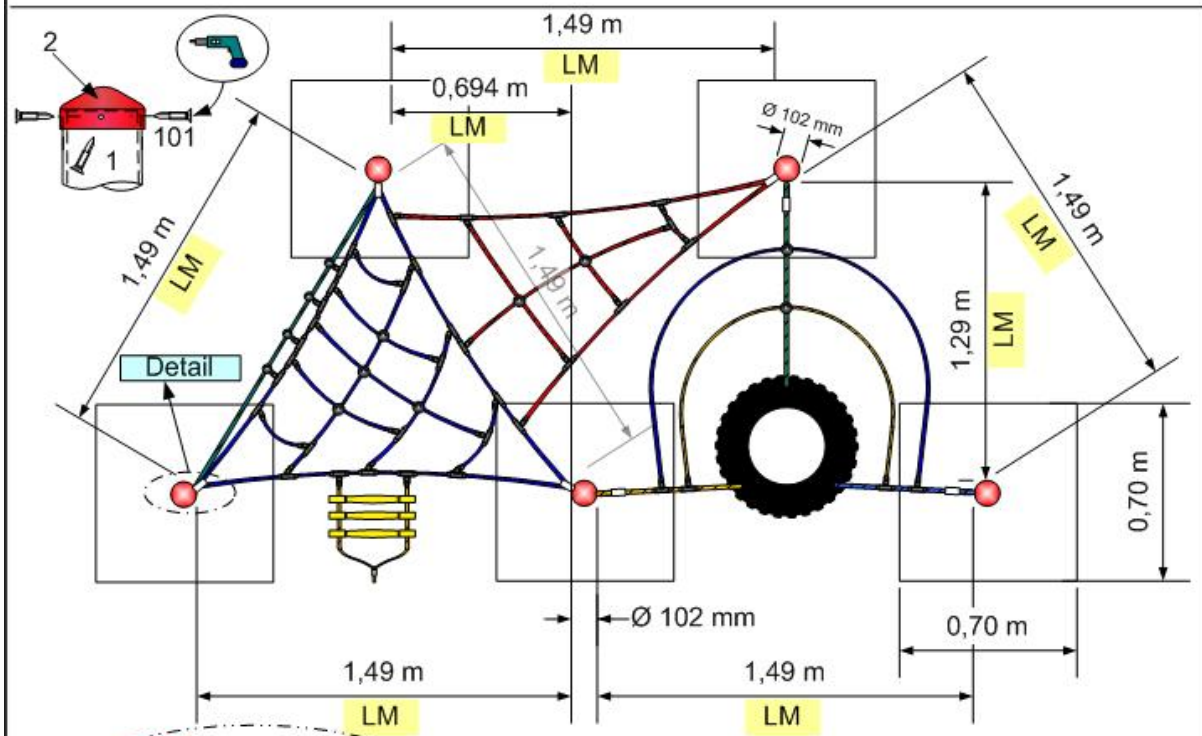
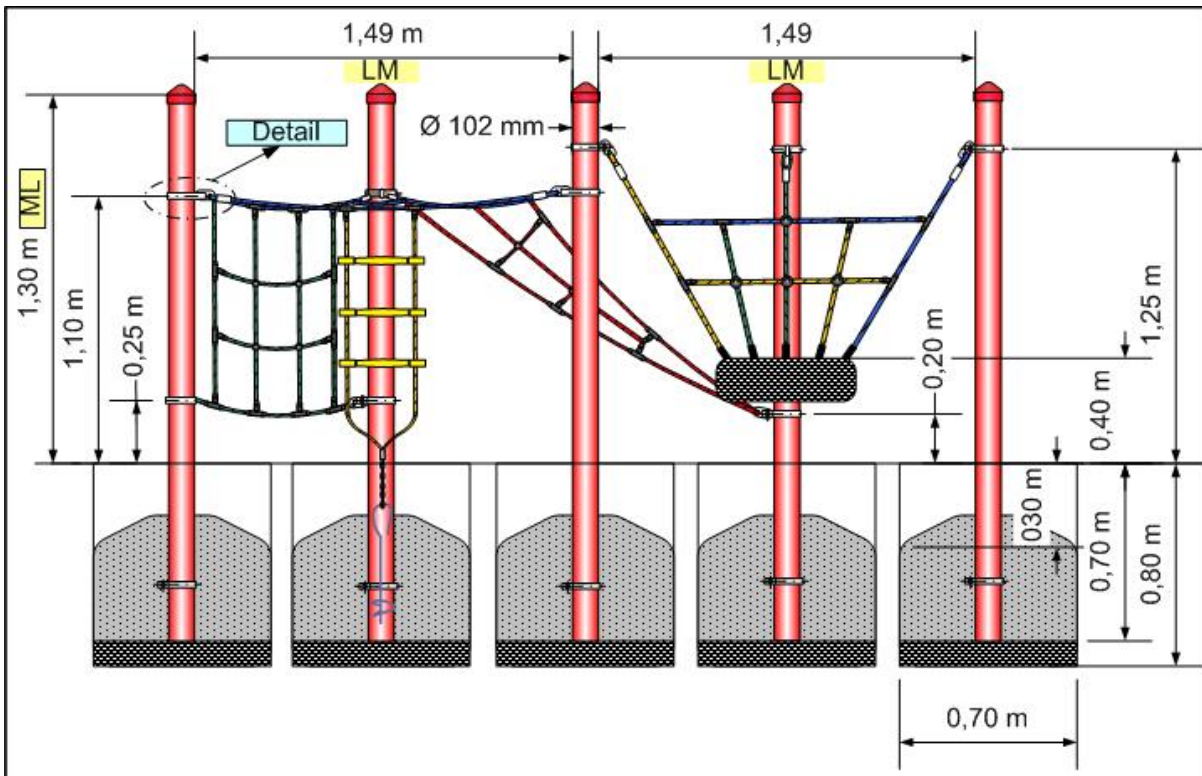

Wichtelwald Berghausen
Art.-Nr. 4594-11

Maßstab: 1:25

Huck Seiltechnik GmbH & Co. KG
Netz- und Seilspielgeräte
Dillerberg 4 D-35614 Aßlar-Berghausen
Postfach 1206 D-35608 Aßlar-Berghausen
Telefon (06443) 8311-0, Telefax (06443) 83 11-79



03.03.04 Henrich

	Version: Gnome Wood „Berghausen“
AB	Setting time at least 7-8 days
D	Concrete C25/30 (for foundations) concrete requirement: ~1 m ³
Dt	Detail
F	Fall protection
FR	Foundation radius at least 10 cm
G	Drainage
LM	Clear dimension
MPF	Middle post
LM	Clear dimension
ML	Mast length above playing level
O.K	Upper edge of playing level
PS	Minimum safety area 26.6 m ²

See drawings

5 Post installation checks



If the equipment has not been installed safely, you must ensure that the public is prevented from using it.

5.1 Marking filler depth

- Labelling the posts to show the depth of material provided as fall protection (i.e. loose filler).

5.2 The equipment has not been installed safely in the following cases:

- Safe equipment installation is not complete.
- The protective surface has not been installed yet.
- Appropriate maintenance work cannot guarantee operational safety.

5.3 Removal of all assembly aids

- Please make sure that all assembly aids have been removed from the playing area. The equipment must not be approved for use until this check has been made.

5.4 Information about inspection of the equipment before it is used for the first time

- There are no special inspection requirements to be met before the equipment is used for the first time.

5.5 Retighten bolts

- After one week of play, please retighten all bolts again. Later upon respective maintenance.

B Maintenance instructions “Berghausen” gnome wood (registered design) Art. 4594-11



Revision history

Revision 0 – 2004-09-20

The first allowed version

Maintenance instruction

Revision 3 – 2011-07-04

Sicherheitsbereich FH

All rights reserved

© Copyright 2004 Huck Seiltechnik GmbH

6 Introduction Maintenance

6.1 General informations

This equipment should be installed, inspected, maintained and operated in accordance with EN 1176-7 guidelines.



Please note: Providing any necessary repairs are carried out, a piece of play equipment that is inspected regularly cannot become so damaged that it is dangerous.

Any spare parts which may be required can be obtained directly from your supplier.



This equipment should only be assembled, maintained and repaired by **persons with the necessary expertise**.
A copy of the inspection record should be given to the operator, who must confirm receipt.

**This maintenance instruction is based on the standard
“EN 1176-1:2008”.**

7 General maintenance information

7.1 Maintenance intervals

Maintenance intervals are based on average use. Please note that more frequent inspections and/or maintenance are required if the play equipment is subject to intensive use.

7.2 Inspection frequency

The frequency of inspections must be based on actual use. Factors that affect frequency include vandalism, location (e.g. coastal proximity), air pollution and the age of the equipment.

7.3 Maintenance products and procedures

All nuts and bolts are hot-dip galvanised or stainless steel. One of the characteristics of stainless steel is that uncontrolled cold welding may occur when the nuts are tightened. To prevent this, it is necessary to spray the nuts and bolts with Teflon spray or another similar lubricant.

7.4 Spare parts

All spare parts must conform to the manufacturer's specifications.

7.5 Identifying spare parts

All spare parts are listed in the parts list. The parts list follows the installation requirements.

7.6 Special instructions for the disposal of individual equipment components

No special instructions are necessary for the disposal of individual equipment components.

7.7 Special measures during the break-in period

No later than 2 weeks after assembly, all screwed connections should be checked and tightened if necessary.

7.8 Drainage holes

All drainage holes should be kept clear.

7.9 Maintenance of protective surfaces

Surfaces providing fall protection must also be maintained regularly. It is particularly important to maintain the correct level of loose surface material and add more if necessary.

7.10 Faults



Attention

Faults must be repaired as soon as they are detected. If serious defects that compromise safety cannot be repaired straight away, the public must be prevented from using the equipment with immediate effect.

7.11 Loose screws



Attention

Loose screws always cause quality problems and put safety at risk. Therefore, loose screws should always be tightened and checks carried out to ensure that there are no missing screws (e.g. look out for holes you can see through).

7.12 Preventing equipment use

Use of the equipment should be prevented in the event of incomplete installation, disassembly, maintenance, repairs and faults.

7.13 Safeguarding the guarantee

Steel posts and footings are guaranteed if regular maintenance is carried out and recorded in writing. Maintenance first takes place after 3 years. The steel posts must be excavated as far as the concrete foundations and checked for corrosion. Zinc paint should be applied to any corroded areas and scratches.

8 Specific maintenance advice

None

9 Maintenance timetable

9.1 Special advices

9.1.1 Maintenance interval

We strongly advise you to carry out inspections and maintenance work within the specified periods as use of the equipment, the weather and malicious vandalism cause wear and tear that compromises the safety and function of the equipment.

9.1.2 Maintenance intervals in the event of intensive use

Please note that more frequent inspections and/or maintenance are required if the play equipment is subject to intensive use.

9.1.3 Faults that compromise safety



In the event of a fault that compromises safety, quick action must be taken. This may involve repairing it immediately or shutting down and dismantling the equipment.

9.1.4 Faults that compromise function



Faults that compromise function should also be repaired immediately. Such faults lower the value of the equipment to the user and encourage malicious vandalism, which may render the equipment less safe. Any damage should also be repaired immediately.

10 Monthly maintenance

- Check the spaces between the equipment and the ground (clearance and height of fall).
- Check the ground surface in the area with fall protection for hard objects and loose foundations.
- Check all connecting elements and fittings for wear and tear and tighten if necessary. Replace damaged or missing parts.
- Check that moving metal parts (joints, springs, etc.) move smoothly and are not worn. Replace if necessary. It is not necessary to lubricate joints as we only use maintenance-free metal roller bearings.
- Check all attachments such as chains, ropes, nets, etc. for damage and replace if necessary.
- Check rubber parts, sleeves, etc. for wear and tear or damage and replace if necessary.
- If necessary, remove excess padding material from the post footings due to danger of rotting.
- Check the surface of wooden parts for damage caused by the weather or external influences and mould. Repair or replace if necessary.
- Check the surface of plastic and metal parts, e.g. slides, for damage and replace if necessary.

11 Quarterly maintenance

- Detailed inspection of the operation and stability of the equipment paying particular attention to any wear and tear.
- Tighten all forms of attachment.
- Repaint and retreat surfaces.
- Maintenance of fall protection surfaces.
- Lubrication of joints.
- Check the height of the fall and top up with loose filler if necessary. If the posts are labelled, top up as far as the mark.
- Retighten all bolts



Annual Maintenance

12 Annual maintenance

- Ascertaining that the equipment, foundations and surfaces are safe for operation.
- In particular, the equipment should be checked for decay and corrosion. It may be necessary to dig out or excavate certain components in order to do so. Zinc paint should be applied to corroded areas and scratches.
- Stability (check posts, bracing, foundations, etc.).
- Ascertaining whether there are any changes in equipment safety as a result of repairs that have been carried out or components that have been added or replaced.



The equipment must be inspected by someone **with the necessary expertise** in strict compliance with the instructions issued by Huck Seiltechnik GmbH .

A copy of the inspection record should be given to the operator, who must confirm receipt.

13 Maintenance printout

Name of item: “Berghausen” gnome wood (registered design) / Art. No. 4594-11 _____

Location: _____

Customer or operator: _____
(Town, Town council, Kindergarten)

Date of inspection	Inspector	O.K.	Accessible	Barriered	Defects	Repaired by	Date

14 Hand over document



After the installation of the equipment pass the installation and maintenance documents to the operator. The operator has to receive the hand over documents. The complete filled and signed hand over document should be sent to the supplier.

Art.-No.: 4594-11

Type of item: "Berghausen" gnome wood

Serial number: _____

Customer or operator (Town, Town council, Kindergarten, etc.):

Competent person in charge:

Installation company (address):

Responsible assistant (assembler):

Received the complete assembly instructions, maintenance instructions and maintenance printout .

(Signature of operator)
(Stamp)

(Signature of installation company)

Date: _____